



/// V_{Cs} A

01

02

62

04

07

/// V_{Bs} D

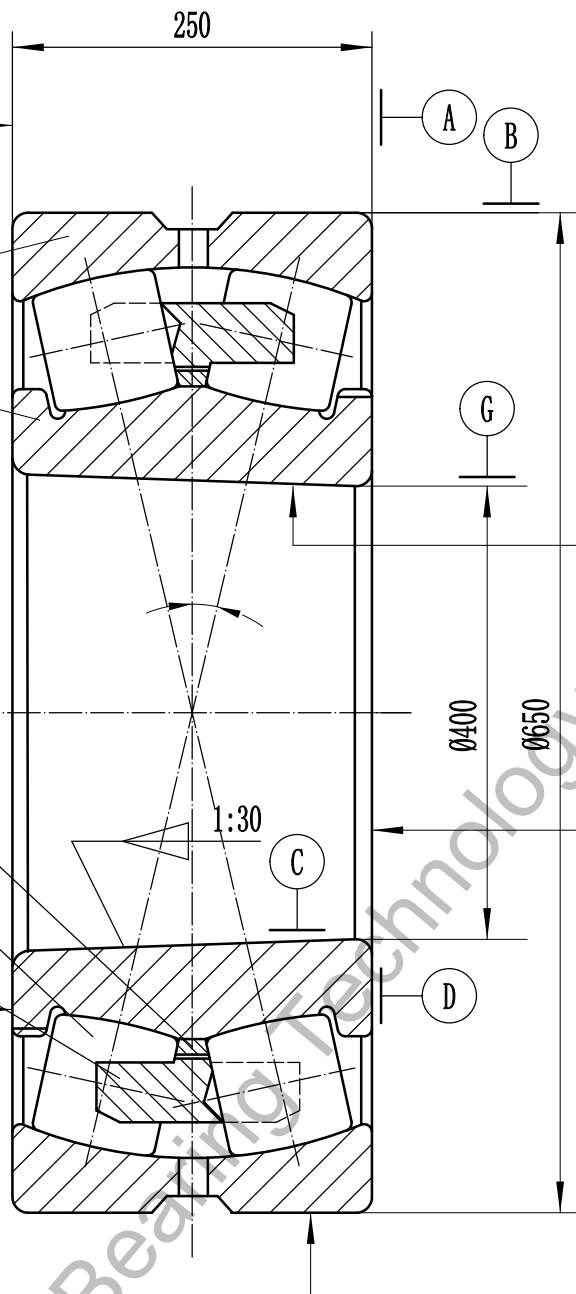

⊖ V_{dsp}
 ⊘ V_{dmp}
 ⚡ K_{ia} B

⚡ S_d G

⊖ V_{Dsp}
 ⊘ V_{Dmp}
 ⚡ K_{ea} C
 ✓ S_D A

- 1、Tolerance of running accuracy are according to relevant state standard;
- 2、The value of the basic group of radial clearance:min **** max ****;
- 3、Rated load: Cr= **** kN Cor= **** kN.

62	Guide ring		Steel 20—GB/T699			
07	Cage		Brass CuZn39Pb2—EN 1652:1997			
04	Roller		Steel 100CrMnSi6-4—ISO 683-17:1999			
02	Inner ring		Steel 100CrMnSi6-4—ISO 683-17:1999			
01	Outer ring		Steel 100CrMnSi6-4—ISO 683-17:1999			
No.	Designation	Qty	Material	unit	toatl	Remark
				Weight (kg)		

Luoyang JCB Bearing Technology Co., Ltd
 Contact information
 Company Address : No. 285, Fenghua road,
 Luoyang, Henan, China.
 Postal code : 471000
 Phone :86-379-68611678
 Fax : 86-379-68611679
 E-mail: sales@jcb-bearing.com
 Reserved E-mail: sales@sphericalrollerbearing.net
 Website: www.jcb-bearing.com
 www.sphericalrollerbearing.net

Spherical Roller Bearing

24180 ECAK30/W33

			Weight(kg)	Scale
S				—
Total page 5			Page No. 1	